

GLP20+ black

Cable gland with locknut, polyamide, M20, RAL 9005

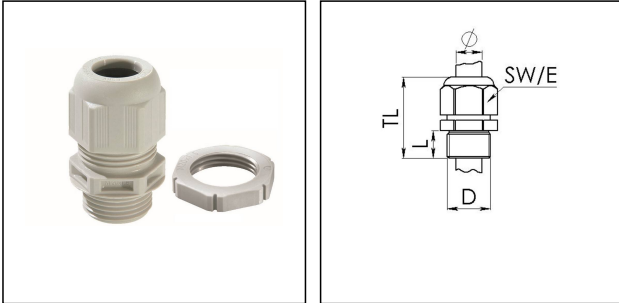

Products may differ in size, colour and appearance to those shown. If you require further information or customisation, please contact us directly.



Material cable gland	Polyamide
Material sealing gasket	EPDM
Temp. range min	-40 °C
Temp. range max	100 °C
Protection class	IP69, IP68 (5 bar 30 min)
Thread type	M
Ø Connection thread D	20
Lead	1,5
Length screw-in thread L	10 mm
Ø cable diameter min	7,5 mm
Ø cable diameter max	14 mm
Key width SW	24 mm
Collar diameter (E)	27 mm
Total length TL	36 mm - 45 mm
Glow wire test	750 °C
Type of cable anchorage	A
Install. torques fitting	4 N m
Install. torques cap nut	3 N m
Product Color	RAL 9005
Order no. RAL 9005	10100612
Type	GLP20+ black
Packing unit	10

14.10.2020

Your Contact:

WISKA Hoppmann GmbH

Kisdorfer Weg 28 · 24568 Kaltenkirchen · Germany

☎ +49-4191-508-0 · 📠 +49-4191-508-209

contact@wiska.de · www.wiska.com



Your Contact:

WISKA Hoppmann GmbH

Kisdorfer Weg 28 · 24568 Kaltenkirchen · Germany

☎ +49-4191-508-0 · 📠 +49-4191-508-209

contact@wiska.de · www.wiska.com